



# SJIII 4740

## ELECTRIC SCISSOR LIFTS

### STANDARD FEATURES

- Drivable at full height
- Variable speed, front wheel hydraulic drive
- DC Motor controller
- Half height hinged gate
- Dual holding brakes
- Proportional controls for drive & lift functions
- 3' (0.9 m) Roll out extension deck
- 24V DC power source
- Low voltage battery protection
- 25% Gradeability
- Solid rubber, non-marking tires
- Pothole protection system
- 110V AC outlet on platform with GFI
- 28 mph wind rating (12.5m/sec)
- Tilt alarm with drive & lift cut-out
- All motion audible alarm
- Lanyard attachment points
- Operator horn
- Hinged railing system
- Forklift pockets and tie down/lift lugs
- Relay based control system
- Color coded and numbered wiring system
- Telematics ready

### ACCESSORIES AND OPTIONS

- Flashing light
- Dual flashing lights
- Extended control box cable
- 800W AC inverter
- AGM Batteries
- Drywall/board carrier
- Heavy duty pipe rack
- Full height spring hinged gate
- Non destructive testing
- Warranty options (3 year or 5 year plans available)

† Standard lead times may be increased when optional equipment is added, consult factory.

‡ Capacities, and machine weights may differ when options are added.

# SJIII 4740 ELECTRIC SCISSOR LIFTS

Dimensions	SJIII 4740
<b>A</b> Work Height	45.3' (13.8 m)
<b>B</b> Raised Platform Height	38.7' (11.8 m)
<b>C</b> Lowered Platform Height	54" (1.37 m)
<b>D</b> Overall Width	47" (1.19 m)
<b>E</b> Overall Length (Platform Retracted)	94.5" (2.40 m)
<b>F</b> Stowed Height (Rails Up)	97.5" (2.48 m)
<b>G</b> Stowed Height (Rails Down)	87.3" (2.21 m)
<b>H</b> Platform Width (Inside Railing)	42" (1.06 m)
<b>I</b> Platform Inside Length (Retracted)	86" (2.19 m)
Specifications	SJIII 4740
Extension Deck (Roll Out)	3' (0.9 m)
Ground Clearance (Pothole Raised)	3.19" (8.1 cm)
Ground Clearance (Pothole Deployed)	0.75" (1.9 cm)
Wheelbase	73" (1.85 m)
Weight	7480 lbs (3393 kg)
Gradeability	25%
Turning Radius (Inside)	21" (0.54 m)
Turning Radius (Outside)	101" (2.58 m)
Lift Time (With Rated Load)	71 sec
Lowered Time (With Rated Load)	41 sec
Drive Speed (Stowed)	2.0 mph (3.2 km/h)
Drive Speed (Raised)	0.62 mph (1.0 km/h)
Maximum Drive Height	Full Height
Capacity (Overall)	500 lbs (227 kg)
Maximum # of Persons	2
Wind Rating	28 mph (12.5 m/s)
Tire Type	Solid, N/M
Tire Size	16 x 5 x 12

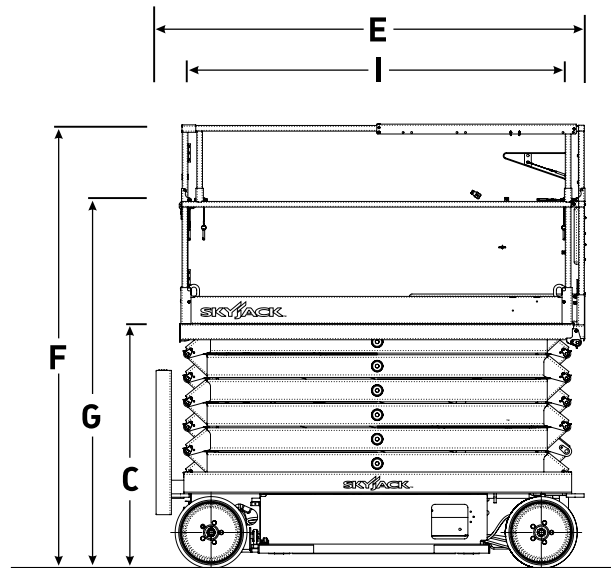
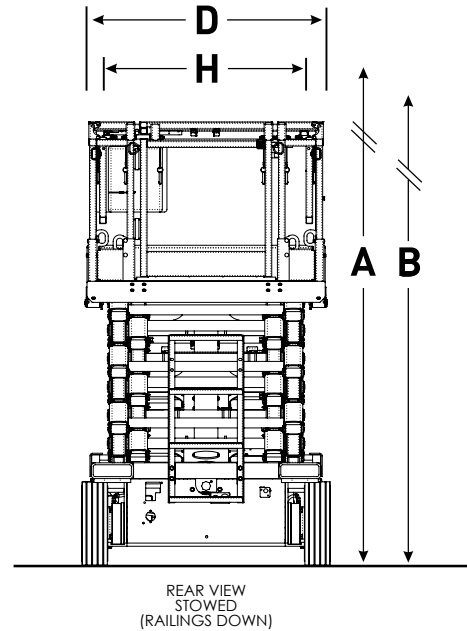

**Skyjack Head Office**  
 55 Campbell Rd. Guelph, ON Canada N1H 1B9  
 Sales Inquiries: 1-877-755-4387 (1-877-SJLIFTS)  
 Main Switchboard: 1-800-265-2738  
 Phone: 519-837-0888  
 Fax: 519-837-8104  
 Email: skyjack@skyjack.com  
 www.skyjack.com

This brochure is for illustrative purpose only and based on the latest information at the time of printing. Skyjack Inc. reserves the right to make changes at any time, without notice, to specifications, standard and optional equipment. Consult the Operating Maintenance and Parts Manuals for proper procedures. Work platforms have been tested to comply with ANSI and CSA standards as interpreted by Skyjack Inc.

